

# USER MANUAL



## VENTILATOR ADAMIK VAN 100

# CONTENT

1. IDENTIFICATION DETAILS .....	4
2. BASIC INFORMATIONS .....	4
2.1 PURPOSE OF THE MANUAL .....	4
2.2 USED SYMBOLS .....	5
2.3 DEFINITION OF OPERATOR QUALIFICATIONS.....	6
3. SAFETY INFORMATIONS.....	6
3.1 RESIDUAL RISKS.....	7
3.2 GENERAL SAFETY WARNINGS.....	7
3.3 SAFETY PRECAUTIONS FOR HANDLING, ASSEMBLY AND INSTALLATION.....	9
3.4 SAFETY WARNINGS FOR INTENDED USE.....	9
3.5 SAFETY WARNINGS FOR ADJUSTMENT/MAINTENANCE.....	9
3.6 SAFETY WARNING FOR ENVIRONMENTAL IMPACT.....	10
3.7 SAFETY SIGNS LOCATED ON THE MACHINE.....	10
3.8 RISK OF EXTRAORDINARY FORESEEABLE SITUATION .....	11
3.9 FIRE SAFETY.....	11
3.10 SMOKING, WELDING OR USING OPEN FLAMES .....	12
4. HANDLING, ASSEMBLY AND INSTALLATION INFORMATIONS .....	13
4.1 HANDLING, STORAGE AND PACKAGING.....	13
4.2 INSTRUCTIONS FOR MACHINE ASSEMBLY.....	13
4.3 FAN ASSEMBLY .....	15
4.4 ELECTRICAL CONNECTION.....	16
4.4.1 Connection to the power supply network .....	17
4.4.2 Machine tests .....	18
4.4.3 Safety of work with electrical equipment .....	18
4.5 TEST OPERATION .....	19
5. TECHNICAL INFORMATIONS .....	20
5.1 MANUFACTURER AND MACHINE IDENTIFICATION .....	20
5.2 DESCRIPTION OF THE MACHINE AND OPERATION CYCLE .....	20
5.3 TECHNICAL PARAMETERS.....	20
5.3.1 Dimensions and weight .....	20
5.3.2 Noise.....	21
5.4 DESCRIPTION OF SAFETY DEVICE .....	22
5.5 PERIMETER AREAS.....	22
6. INFORMATIONS FOR USE.....	22
6.1 RECOMMENDATIONS FOR USE.....	22
6.2 CORRECT USE / IMPROPER USE .....	23
6.2.1 Type of extracted material.....	23

6.3 IN THE CASE OF FIRE .....	24
7. MAINTENANCE .....	25
7.1 MAINTENANCE RECOMMENDATIONS .....	25
7.2 PROHIBITED ACTIVITIES WITH THE FAN .....	26
7.3 TABLE OF SCHEDULED MAINTENANCE INTERVALS .....	26
7.4 CLEANING AND DISPOSAL .....	27
8. PARTS REPLACEMENT INFORMATIONS .....	27
8.1 RECOMMENDATIONS FOR REPLACEMENT OF SPARE PARTS .....	27
8.2 LIST OF REPLACEABLE PARTS .....	28
8.3 DECOMMISSIONING .....	30
9. WARRANTY .....	31
9.1 LIABILITY FOR DEFECTS .....	31
9.2 VOLUNTARY ADDITIONAL WARRANTY .....	31
9.3 EXCLUSIONS FROM LIABILITY FOR DEFECTS AND FROM WARRANTY .....	31
10. TERMS OF SERVICE .....	32

# 1. IDENTIFICATION DETAILS

Name and address of manufacturer/supplier:



ADAMIK Company, s.r.o.  
Mitrovická 804  
739 21 Paskov  
Czech Republic  
VAT nr.: CZ26845318

## 2. BASIC INFORMATIONS

### 2.1 PURPOSE OF THE MANUAL

The purpose of this manual is to provide, in part, the machine operator, operator and maintenance technician with guidance on the use, prevention and reduction of human-machine interaction risks.

Person	Chapters in the manual they must familiarize themselves with
<b>The person installing the unit</b>	<ul style="list-style-type: none"><li>- Basic informations</li><li>- Safety informations</li><li>- Handling, assembly and installation informations</li><li>- Technical informations</li><li>- Parts replacement informations</li></ul>
<b>Operator</b>	<ul style="list-style-type: none"><li>- Basic informations</li><li>- Safety informations</li><li>- Information for use</li></ul>
<b>Maintenance technician</b>	<ul style="list-style-type: none"><li>- Basic informations</li><li>- Safety informations</li><li>- Handling, assembly and installation informations</li><li>- Information for use</li><li>- Maintenance</li><li>- Parts replacement informations</li></ul>

The responsible person must keep the documentation in a suitable place so that it is always available for consultation in a legible and clear state. In case of loss or wear, request replacement documentation directly from ADAMIK Company.

Specific topics of interest are easy to find in the table of contents.

Some information may not fully correspond to the actual configuration of the delivered ventilator.









Any additional information that may be inserted will not affect readability or compromise the level of security.





The manufacturer reserves the right to change the data without being obliged to notify in advance, as long as these changes do not change the level of safety.

Any feedback from operators can be an important contribution to improving the after-sales services that the manufacturer offers to its customers.

Some symbols, the meaning of which is described below, are used to highlight some text or to indicate significantly important specifications.

## 2.2 USED SYMBOLS

Symbol	Description
	<b>Danger – Warning</b> The symbol indicates situations of serious danger which, if neglected, may seriously endanger the health and safety of persons.
	<b>Danger – Warning</b> The symbol indicates situations of serious danger which, if neglected, may seriously endanger the health and safety of persons.
	<b>Danger of explosion</b> This symbol indicates situations of serious danger which, if neglected, can cause an explosion and seriously endanger the health and safety of people.
	<b>Caution – Warning</b> The symbol indicates the need to adopt reasonable behavior in order not to endanger the health and safety of people and avoid economic damage.
	<b>Important</b> The symbol indicates very important technical and operational information that must not be neglected.
	Use protective gloves.
	Wear safety shoes.
	Use a protective face mask.

Symbol	Description
	Use hearing protection.
	Use safety glasses.
	Use a safety helmet.
	For operations at a certain height, use a work-at-height harness.

## 2.3 DEFINITION OF OPERATOR QUALIFICATIONS

Some terms that are frequently used in the manual are described in order to clearly define their meaning.

Operator qualification	Description
<b>Qualified personnel</b>	Employees who have completed specialization, education and training courses and have experience in installation, commissioning and maintenance of equipment
<b>Experienced maintenance technician</b>	A technician selected and authorized from among those who have the qualifications, skills and information to perform routine and emergency maintenance interventions.

## 3. SAFETY INFORMATIONS



***The ADAMIK VAN 100 transport fan can be used to extract non-explosive materials without filtration (welding, grinding, engraving), to transport chips, sawdust, wood chips or other loose materials using a piping system or hoses. It must not be used for easily flammable and explosive materials. It is not recommended for extracting abrasive materials (e.g. metals). Pieces of wood (knots, etc.) must not be extracted, which may cause breakage or deformation of the impeller. The extraction device is suitable for environments without the risk of fire.***



***Carefully read the instructions in this manual and the instructions specific to the machine and on the machine.***

### 3.1 RESIDUAL RISKS

Residual risk	Description
Voltage hazard	Maintenance work carried out on the electrical parts of the machine carries with it the risk of electric shock.
Dust inhalation hazard	Maintenance activities carried out inside the machine involve the risk of inhaling potentially carcinogenic dust.
Fire hazard	Routine operations performed in spite of the prohibition described in the "Correct use/ Improper use" chapter. Maintenance operations performed despite the prohibition described in section "7.1 Maintenance recommendations".
Explosion hazard	Maintenance operations carried out despite the prohibition expressed in section "6.2 Correct use / Improper use". Maintenance operations carried out despite the prohibition expressed in section "7.1 Maintenance recommendations".
Cutting hazard	Maintenance operations carried out without the use of protective gloves for the removal of moving sheet metal parts carry the risk of cutting fingers.

### 3.2 GENERAL SAFETY WARNINGS

Personnel carrying out any type of intervention throughout the life of the machine must have precise technical skills, special abilities resulting from acquired and recognized experience in the sector, must be trained in the use of the necessary work tools and appropriate personal protective equipment with reference to the laws in force and in force at the location machine use.

Failure to comply with these requirements may cause harm to people's health and safety.

Use the personal protective equipment specified in the instructions.



***The machine contains potentially explosive dust deposits and/or gases, therefore it is forbidden to approach or introduce any possible source of ignition into the machine:***

- ***Open flame***
- ***Hot surfaces***
- ***Sparks***
- ***Gas***
- ***Electrical parts under voltage***
- ***Electrostatic charge***

**Rotating or moving parts of the fan, parts under electrical voltage, thermal differences in temperature or pressure circuits can cause serious or fatal injuries. Assembly, connection, commissioning as well as maintenance and repairs may only be carried out by qualified, trained personnel in compliance with:**

- **The provisions of these operating instructions**
- **The currently valid regulations on occupational safety and accident prevention.**
- **A damaged fan must never be put into operation.**
- **Before operating the fan in any way, read these operating instructions carefully.**
- **It is essential to follow the safety instructions contained in these operating instructions.**
- **The fan may only be operated by personnel who are over 18 years of age, mentally and physically fit, trained and authorized to operate the fan.**
- **Personnel operating and maintaining the fan must be demonstrably familiar with these operating instructions.**
- **Only perform adjustments, maintenance and cleaning of the fan when the fan is at a standstill, with the main switch switched off and secured and the power supply disconnected.**
- **Do not start the fan without covers and do not enter the working area of the fan.**
- **Do not touch moving parts.**
- **Keep the safety signs on the machine legible.**
- **If the permissible noise limit specified in the relevant government regulation is exceeded at the workplace, the operator must be protected with appropriate protective equipment - headphones or earplugs.**
- **Work only in good lighting conditions or ensure adequate artificial lighting.**
- **Always make sure that all protective devices are installed and that they function properly.**
- **Never work with the fan when you feel tired.**
- **Have damaged machine parts replaced by a specialist. They may only be replaced with original parts.**
- **If the device starts to vibrate unusually strongly, shows increasing noise or other symptoms that are not normal during its operation – turn off the fan and ensure immediate inspection.**
- **Make sure that nuts, bolts and screws are firmly tightened and that the fan is always in a technical condition appropriate for safe operation.**



**The operator is obliged to use personal protective equipment according to the nature of the machine and the employer's requirements.**



**It is forbidden to connect the fan to the electrical network unless it has been connected to the piping system or to the machinery that is not equipped with a barrier to prevent access to the impeller.**



**Fans are not ready-to-use products and may only be put into operation after connection to machinery, piping systems or if their safe operation has been ensured by a cover against contact with moving parts of the machine. Fans may not be used in hazardous explosive environments or for exhausting flue gases. Safety accessories (e.g. motor protective grille or protective barriers) may not be dismantled, bypassed or taken out of service..**



***The device may only be used by persons who have been instructed in its use. Use a hose of appropriate dimensions or rigid pipework to connect the fan. To ensure good fan performance, it is important to ensure that an adequate air supply is provided and that the fan capacity meets the requirements set for the machines to which it is to be connected.***

### 3.3 SAFETY PRECAUTIONS FOR HANDLING, ASSEMBLY AND INSTALLATION

Use suitable lifting equipment for handling and take all safety precautions for the activities carried out in the workplace.

Before moving the machine, disconnect it from the electrical supply and the piping system.



***Electrostatic charge built up in flexible pipes could ignite a fire. Therefore, they must have electrical conductivity and be grounded.***



***The machine must be installed in an area where there is no explosion hazard.***

### 3.4 SAFETY WARNINGS FOR INTENDED USE

The machine was designed to work within the limits prescribed and indicated in the manual.

The machine is designed for operation in an environment protected from atmospheric weather.

Using the machine to achieve production levels other than those described in this manual will be considered "IMPROPER USE".

Carefully read the instructions in the section "6. Information for use".

To be prepared for emergency situations, carefully read the instructions in section "6.3 In case of fire".

### 3.5 SAFETY WARNINGS FOR ADJUSTMENT/MAINTENANCE

Perform routine maintenance as described in this manual.

Before any maintenance, disconnect the machine from all power sources.



***Potentially explosive atmospheres may occur during adjustment and maintenance, therefore it is prohibited to approach or introduce any possible source of ignition into the machine:***

- ***Open flame***
- ***Hot surfaces***
- ***Sparks***
- ***Gas***
- ***Electrical parts under voltage***
- ***Electrostatic charge***

### 3.6 SAFETY WARNING FOR ENVIRONMENTAL IMPACT







Before using the machine, the operator must be provided with information, instructions and training on the substances for which the machine is to be used, including how to safely remove and dispose of accumulated pollutants.

Do not disperse polluting material into the environment. Dispose in accordance with applicable laws.

### 3.7 SAFETY SIGNS LOCATED ON THE MACHINE

The following warning labels must be placed on the machine.

Some tags may not be present if they refer to optional components that are not installed.

Symbol	Description
	Grounding
	Danger of drawing limbs, hair and loose parts of clothing into the device's entrance openings.
	Keep limbs, hair, and loose clothing away from the inlet openings. They can be pulled into the inlet openings of the device, which could cause injury.
	Warning.
	Direction of rotation of the rotor.
	<b>DANGER!</b> Risk of serious cuts. Before removing dust caps and hoses, unplug the extractor from the power source and wait 5 minutes for the internal rotating parts to stop.

## Symbol

## Description



**CAUTION!** To reduce the risk of injury from moving parts, keep hands and fingers away from inlet openings. Operate the unit only with inlet openings covered with covers or connected to a flexible hose. The impeller continues to rotate for 5 minutes after the dust collector is turned off. Before servicing or cleaning dusty materials, make sure the dust collector is turned off, disconnected from the power source, and that the impeller has stopped rotating.



**WARNING!** This appliance contains dust hazardous to health. Waste bag and filter emptying and maintenance operations, including the removal of dust collection components, must only be carried out by authorised personnel wearing appropriate personal protection. Do not operate the dust collector without the filter system fully installed.

### 3.8 RISK OF EXTRAORDINARY FORESEEABLE SITUATION

If an object gets caught in the impeller (long wet chips, rags, paper) it will cause sudden vibrations. The extraction device must be switched off, wait until the impeller stops, and unplug the power cord from the electrical outlet. Then the pipes (hoses, pipe elements) must be dismantled, the impeller cleaned and reassembled.

Qualified personnel must carry out a technical inspection at least once a year, which consists of, for example, checking the filter for damage, checking the air tightness of the machine and the pipe system and the correct functioning of the control and regulation mechanism.

### 3.9 FIRE SAFETY

***Since the manufacturer does not equip the fan with fire extinguisher, the user is obliged to secure the building where the device is installed with suitable fire extinguishers of an approved type, in an adequate quantity, placed in a visible place and protected against damage and misuse.***

***Fire extinguishers are subject to regular inspections and the operator must be demonstrably familiar with their use, as required by the relevant law and decree - "the user's obligation to secure the workplace in accordance with the relevant decree, i.e. install a hand-held fire extinguisher in a suitable place."***

***In connection with the above warning and in accordance with the provisions of the relevant law, the user is obliged to act in such a way as to prevent fire. This means that flammable liquids or other hazardous substances and gases must not be stored near the device during operation, open flames must not be used, smoking must not be allowed and the manufacturer's recommended work procedure must be followed.***



***It is forbidden to extinguish electrical equipment with a water or foam extinguisher! Danger of electric shock! Electrical equipment must not be extinguished with water!***



**Recommended:** Powder, snow or halon fire extinguisher and the operator must be familiar with its use.

The risk of fire increases due to neglect of maintenance, especially settled flammable substances (liquids, dust, etc.) on electrical parts, dust settled on the fins of the electric motor reducing heat dissipation and defects in the electrical installation.

In the event of a fire, follow the fire instructions according to the given workplace.

### 3.10 SMOKING, WELDING OR USING OPEN FLAMES



***It is forbidden to extinguish electrical equipment with a water or foam extinguisher! Danger of electric shock! Electrical equipment must not be extinguished with water!***

***Smoking is prohibited!***

***This applies not only to company employees, but also to guests, customers, foreign workers, drivers, etc.***

***Repairs and construction work that requires welding, lit torches, etc. must be carried out separately, in a specially equipped workshop, where possible.***



***In the event that welding or work with an open flame is necessary, in the production area or storage areas, written permission must be obtained from the responsible manager. Such work must not be started without taking special safety precautions, moistened sheets must be spread out to cover the immediate vicinity and fire extinguishers must be placed near the work area.***

***The work area and its immediate surroundings in which welding will be carried out must be kept under supervision for at least 10 hours after the work is finished. Sprayed or liquid hot metal drops from the cutting flame (welding balls) are extremely dangerous, since the direction and distance of their impact cannot be predicted.***

## 4. HANDLING, ASSEMBLY AND INSTALLATION INFORMATIONS

### 4.1 HANDLING, STORAGE AND PACKAGING



***The standard packaging of the machine does not guarantee protection against rain. The machine must be stored in a closed environment with a relative humidity lower than 70%.***



***The machine must be stored at temperatures between -10 °C and +40 °C inclusive. Store the fans in a dry place protected from weather and dirt until final assembly.***



***Use appropriate lifting equipment when handling materials and observe all safety precautions required for workplace activities. Dispose of the packaging material in accordance with applicable legislation.***

Provide a defined and adequate area with a level floor or surface for unloading and storing packages.

It is always advisable to keep the packaging in a horizontal position during handling to prevent loss of stability and/or tipping over.

### 4.2 INSTRUCTIONS FOR MACHINE ASSEMBLY



***Do not lift the fans by the connection cables, terminal block, impeller or suction opening. Do not allow impacts or shocks.***



***The machine must be installed in a fixed position. The machinery must be mounted in the location specified by the operator's project.***



***The simultaneous presence of two qualified persons is necessary to assemble the machine. They must complete specialization and training courses and must have experience installing, activating and performing system maintenance.***



***The machine must not be assembled by persons under the influence of alcohol, drugs or any other intoxicating substances. Otherwise, there is a risk of injury or death.***



***Before starting the assembly, it is necessary to familiarize yourself with the instructions for assembly and use of the dust collector unit. The individual assembly steps must be carried out exactly in the order given in this manual.***



***Before assembly, visually inspect the material to ensure that it has not been damaged in transit. If it shows signs of damage, please notify the seller within 2 days of delivery.***



**Before proceeding with the assembly, read the paragraph "4.3 Installing the machine".**



**During assembly, use the personal protective equipment specified in the manual.**



**For transport reasons and/or on the basis of special agreements between the customer and the supplier, the parts required to assemble the machine may differ from the parts described in the assembly description.**



**Before opening the package, tilt the box just enough to prevent the material from tipping over. Do not exceed the maximum angle shown in the figure below.**

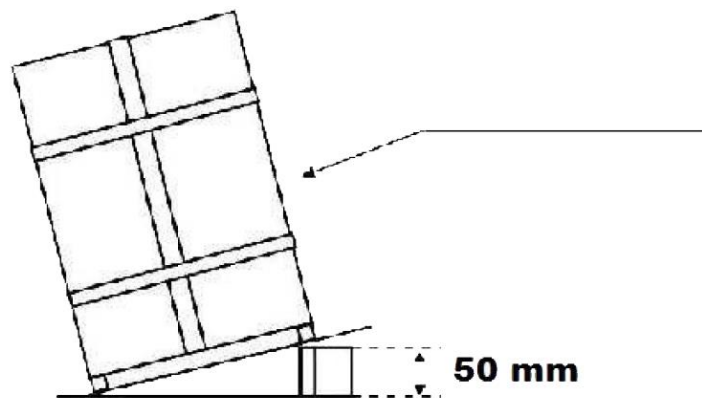

**Before assembly, it is necessary to know the weight of the components.**



**Use suitable lifting equipment for handling.  
Take all the safety precautions prescribed for the activities carried out in the workplace.**



**Electrostatic charge accumulated in flexible pipes could cause a fire. Therefore, they must be electrically conductive and grounded.**



**The machine must be installed in a non-explosive environment.**



**The dust collector unit is designed for operation in an environment protected from atmospheric weather.**



**For information on the correct installation of the machine and the correct dimensioning of the suction pipe, please contact the technical department of ADAMIK Company in advance.**

## 4.3 FAN ASSEMBLY



**Use personal protective equipment during assembly.**



**To dissipate electrostatic charge, the extraction device must be grounded (either by connecting to a protective connection or to the ground itself) by a person with appropriate electrical qualifications.**



**The machine is designed for operation in an environment protected from atmospheric weather.**



**For information on the correct installation of the machine and the correct dimensioning of the suction pipe, please contact the technical department of ADAMIK Company in advance.**



**Before handling the machine, check that the overall dimensions and weights are necessary to carry out work and maintenance without any restrictions on handling and positioning the machine.**



**The machine must be installed on a flat surface.**



**For proper air extraction and cooling of the fan, the fan motor must be installed at least 30 cm from the nearest obstacle (wall, machine, etc.)**



**Before starting the installation, make sure that the distance between the fan and the work surfaces is sufficient to minimize the risk of inhaling dust emitted during the fan cleaning phase.**



**The fans are not equipped with motor overload protection, therefore they must be connected to the electrical network via external motor protection (motor starter with thermal protection)!**



**The fan must be connected to the electrical network via a fixed cable terminated with a lockable main switch for disconnecting all phases. This connection will ensure that the device can be safely shut down later in the event of maintenance or repair of the fan or air conditioning system.**



**The installation of fans, connections and all electrical installation must be carried out only by a knowledgeable person.**

**When using an electric motor in a secured version, it is necessary to comply with Annex A, ČSN EN 50019/9.93. Installation and operation of the fan must be in accordance with the requirements of ČSN EN 60079-14/1999 part 14. Electrically conductive parts of air-conditioning equipment must be conductively connected. Fans intended for explosion-hazardous environments zone 2 must be grounded during installation. Fans must be operated at an appropriate pressure load so as to prevent overloading of the electric motor (see data on the electric motor label). If an air-conditioning duct is connected to the fan, the connection must be equipped with a damping insert.**

- The electrical connection must be made according to the wiring diagram in the terminal box of the electric motor according to the markings on the terminals or cables.
- The fan is supplied from the factory for connection to a 230 V network.
- Mount the fan in accordance with the direction of air flow (see arrow on the unit).
- Ensure that the fan is mounted firmly and stably.

Installation and initial inspection are carried out by the operator

- For installation, see section "4.2 Instructions for machine assembly".
- It is recommended to install the fan close to utility networks and connect it to collection systems using rigid pipes or hoses.
- Place the fan in an environment with an operating temperature of +5 °C to +40 °C.
- To reduce the sound level due to reverberation, do not place the fan in corners, near walls and ceilings or on recessed metal structures.

## 4.4 ELECTRICAL CONNECTION



**Use personal protective equipment during assembly.**



**Use personal protective equipment as specified in the instructions.**



**Before making electrical connections, verify the correct power source.**



**The electrical connection must be carried out by qualified personnel. The manufacturer is not responsible for damage to the extraction device or other workshop equipment due to incorrect or unprofessional installation of the device!**



**Connect the machine to the grounding conductor using a copper braided wire in accordance with the regulations in force in the country in which it is installed.**



#### 4.4.1 Connection to the power supply network



***The value of the operating voltage and its frequency must correspond to the data stated on the machine label. The correct operation of the electrical equipment is ensured with a permissible fluctuation of the nominal value of the supply voltage of  $\pm 5\%$ . The machine must be connected with correctly dimensioned wires to the supply terminal block.***

The electrical equipment is designed for the following conditions. If operation beyond the conditions described below is required, an assessment must be made to keep the electrical equipment in good and safe operation.

- Ambient air temperature: +5 °C to +40 °C in open air and the average ambient air temperature over a 24-hour period must not exceed +30 °C.
- Humidity: 30 % to 70 %.
- Altitude: up to 1000 m above mean sea level.
- Conditions for transport and storage: -10 °C to +40 °C.

1) Check:

- voltage
- network frequency and phase

The correct data for using the machine are given on the label located on the machine or in the technical data table in the manual.

2) Connect the power supply.

Connection to the electrical network is ensured by a movable power cord, by inserting the plug into a 230 V electrical network socket.

Connect the motor to the electrical network in accordance with current safety regulations. Before starting the device, check that it is properly grounded.

Check that the supply voltage and frequency correspond to the specifications on the motor nameplate. Including overvoltage protection. Remember that the calibration current of the thermal or earth leakage circuit breaker must not exceed the specifications on the nameplate.

To protect the control device, it is necessary to use fuses with an adequate current. The total length between the fuse and the terminal must not exceed 1.5 m.



***In the event of a power outage, the operator must turn off the power switch and unplug the power cord from the electrical outlet. Restarting is performed according to the instructions in this user manual.***



***The workplace must be equipped with an appropriate fire extinguisher.***



***All maintenance work should be carried out by a qualified person.***



***Follow the instructions in this manual to properly connect and disconnect the fan.***

***This fan is turned on by pressing the “I” button and turned off by pressing the “O” button.***

***Under normal conditions, only operate this fan using these two buttons.***

## 4.4.2 Machine tests

After complete connection, the electrical equipment of the machine must be tested according to the applicable standards of the country where the equipment is operated. A written document must be issued confirming the inspection.

## 4.4.3 Safety of work with electrical equipment

### **Operator's obligations**

- Maintain electrical equipment in a permanently safe and reliable condition that complies with the valid electrotechnical regulations ČSN, ČSN EN, ČSN ISO and ČSN IEC, only by persons knowledgeable according to the valid ČSN 34 3100 and with a valid Test Certificate according to the Decree of the Czech Electrical Inspectorate No. 50/1978 Coll., which authorizes independent work on electrical equipment (Section 6 or higher).
- Carry out regular inspections and inspections of electrical equipment within the specified deadlines
- Ensure that persons without electrical qualifications (lay people) do not interfere with the electrical equipment of the working machine in an unauthorized manner and that no work is carried out in them in accordance with the valid standards and regulations: Demonstrably familiarize all persons who will operate the electrical equipment in question with the permitted operation and safety regulations, as well as the possible risk of electrical injury.
- After installation, it is necessary to carry out an electrical inspection according to the valid regulations and standards. This inspection must also include a grounding check!

### **Operating electrical equipment**

- Only persons with the qualifications required for the relevant equipment may operate electrical equipment.
- Persons operating machines and equipment must be familiar with the equipment being operated and its function. Where local or other safety and work regulations or instructions have been drawn up, they must be accessible at a suitable location and workers must be demonstrably familiar with them.
- The operator may only touch those parts that are intended for operation. The parts to be operated must always be freely accessible.
- In the event of damage to electrical equipment or a fault that could endanger the safety or health of workers, the worker who discovers such a condition and cannot eliminate the causes of the danger himself must take measures to prevent or reduce the risk of injury, fire or other danger.
- When moving electrical appliances, they must be safely disconnected from the power supply beforehand.
- Persons without professional electrical qualifications (laymen) may operate small and low voltage electrical equipment themselves, which are designed in such a way that they cannot come into contact with uncovered live parts of electrical equipment under voltage when operating them.
- Persons without professional electrical qualifications (laymen) may:
  - switch simple electrical equipment on and off
  - when the electrical equipment is switched off, they may move and extend movable leads using connecting cords equipped with appropriate connecting parts

- replace melted inserts of screw-type and device fuses only with new inserts of the same value (they may not repair melted inserts)
- maintain electrical equipment according to the manufacturer's instructions
- Before moving electrical appliances (equipment) connected to the electrical network by a movable lead with a plug, they must be safely disconnected from the network by pulling the plug out of the socket.
- Before moving electrical equipment connected to the electrical network by a fixed or flexible cable must be safely disconnected from the network.
- When operating electrical equipment, the operator must observe the relevant instructions and local operating regulations for its use, as well as ensure that the equipment is not excessively overloaded or otherwise damaged.
- If a defect in the equipment is detected during operation (e.g. damage to the insulation, burning smell, smoke, unusually noisy or jerky operation of the electrical equipment, strong humming, jerky start-up, excessive heating of some part of the electrical equipment, sparking, tingling from electric current), the electrical equipment must be switched off immediately and the defect reported to the electrical equipment maintenance person or a superior.
- Damaged electrical equipment must not be used.

## 4.5 TEST OPERATION



***Connect the machine to the grounding conductor using a copper braid in accordance with the regulations in force in the country in which it is installed.***



***Check that the connected machine is installed correctly.***



***Check the tightening of the screws.***



***Check the direction of rotation of the ventilator rotor.***



***Check that the edevice does not vibrate or make excessive noise.***



***Check the tightness of the connections of the piping system and the unit. Apply silicone sealant to any leaks BEFORE STARTING OPERATION.***

During operation, it is necessary to monitor in particular:

- the correct function of the device and its smooth operation,
- the cleanliness of the machine and its surroundings,
- load the machine according to its label values and check the temperature of the bearings,





***The fan must not be started before it is connected to the air duct or hose.***

## 5. TECHNICAL INFORMATIONS

### 5.1 MANUFACTURER AND MACHINE IDENTIFICATION

The manufacturer's identification is indicated on the identification plate and on the declaration of conformity.

The plate indicates the manufacturer's data and the technical data necessary for correct and safe use.

		ADAMIK Company, s.r.o. Mitrovická 804 739 21 Paskov Czech Republic			
TYP / TYPE					
VÝROBNÍ ČÍSLO / PRODUCTION NO.					
KAPACITA / CAPACITY		m <sup>3</sup> / h			
PODTLAK / UNDERPRESSURE		Pa			
PŘÍKON / POWER		kW /		A	
NAPĚTÍ / VOLTAGE		V /		Hz	
VÁHA / WEIGHT		kg			
ROK VÝROBY / PRODUCTION YEAR		20			

### 5.2 DESCRIPTION OF THE MACHINE AND OPERATION CYCLE

ADAMIK transport fans of the VAN 100 series are intended primarily for the extraction of non-explosive materials without filtration (welding, grinding, engraving), for the transport of chips, sawdust, wood chips or other loose materials using a piping system or hoses.

The fan is designed for connection to woodworking machines to extract wood shavings and finer chips generated during operation.

### 5.3 TECHNICAL PARAMETERS

#### 5.3.1 Dimensions and weight



***The stated extraction capacity can be achieved under optimal conditions. The extraction capacity may vary depending on the type of extracted substance, its concentration, environmental parameters, hours worked, etc.***

***For the correct filter size setting for the desired application, please contact the ADAMIK Company technical office.***

	Unit	VAN 100
Motor power	kW	<b>0,75</b>
Extraction capacity (max)	m <sup>3</sup> /h	1 250
Underpressure (max)	Pa	900
Voltage	V / Hz	230 / 50
Connection to hose	mm	100
Output dimension	mm	125
Noise	dB	75
Height	mm	400
Width	mm	360
Length	mm	420
Weight	kg	20

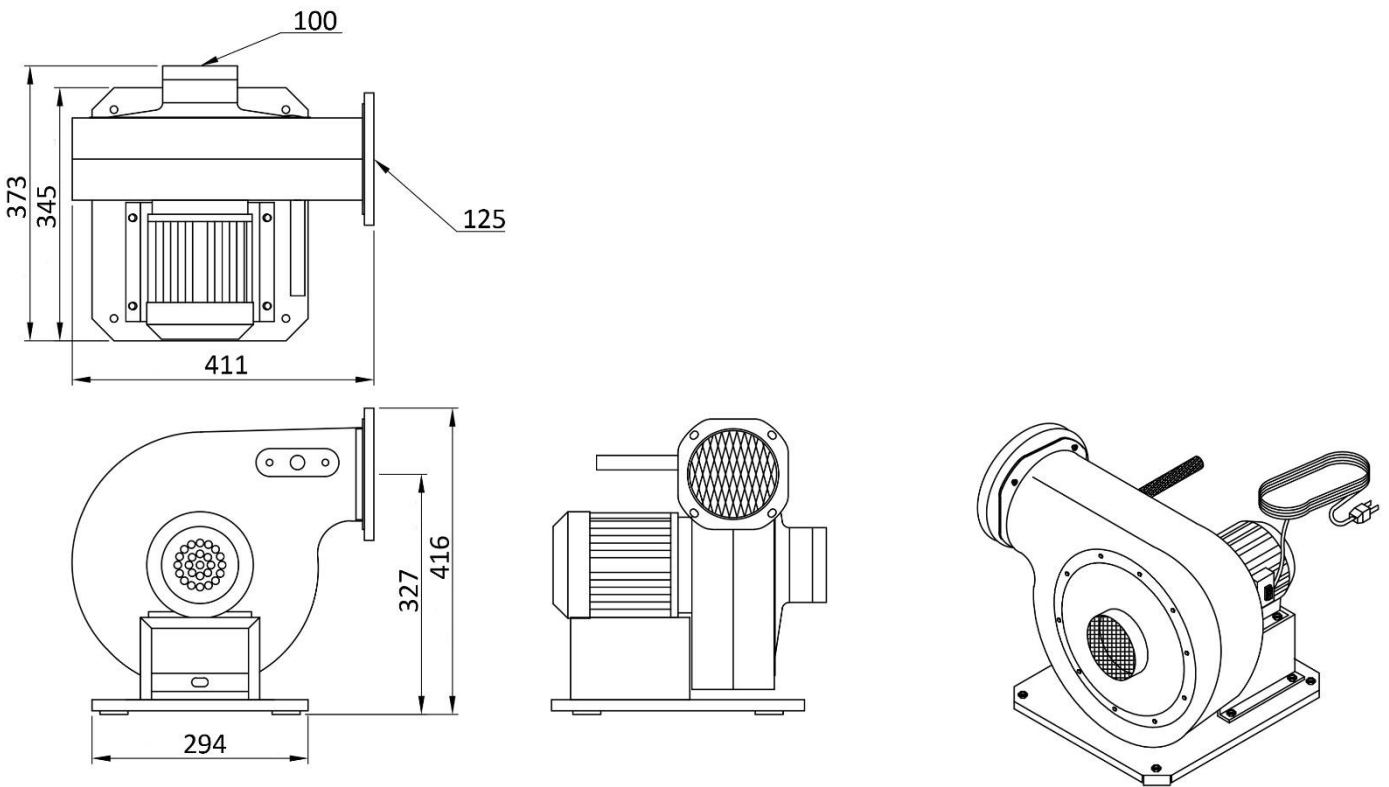

### 5.3.2 Noise



**To reduce noise levels due to reverberation, we do not recommend installing the extractor near corners, walls or over metal boxes.**



#### **WARNING!!**

**Check the legislative requirements in force in the country of installation and, if necessary, use:**

- **Personal protective equipment**
- **Any soundproofing screens**

## 5.4 DESCRIPTION OF SAFETY DEVICE

The machine is originally equipped with the protective systems necessary for working in safe conditions.

In the case of connection to other machines, the end user is responsible for evaluating the associated risks.

## 5.5 PERIMETER AREAS



***When installing, pay attention to the necessary overall dimensions required for machine maintenance.***



***When installing, take into account the dimensions of any optional parts and accessories.***



***When installing, take into account the dimensions of the connected device and the space for its operation.***

When installing, ensure that there is enough space for the machine to operate at full capacity. (See section "5.3.1 Dimensions and weight").

Minimum area required for the machines to be placed: 700 x 650 mm.

## 6. INFORMATIONS FOR USE

### 6.1 RECOMMENDATIONS FOR USE



***The machine is designed for operation in an environment protected from atmospheric weather.***



***The machine is designed to operate at an ambient temperature between +5 °C and +40 °C.  
It is recommended to use an operating temperature not higher than 40 °C.***



***Any other use of the machine must be approved in advance by ADAMIK Company.  
If the user does not have written authorization, the manufacturer and supplier refuse any liability for damage to persons or property, and the warranty on the line and machinery will also expire.***



***To extract waste containing larger solid pieces (particles larger than 1 x 1 cm) that could damage the rotor or the entire fan, it is necessary to use a heavy piece trap placed in front of the fan's suction nozzle.***



***It is prohibited to:***

- Use the fan without reading this User Manual.***
- Start the fan without connecting hoses or pipes to the fan intake.***

- **Perform any cleaning or maintenance operations inside the hose or pipes connected to the fan intake unless the fan is switched off and secured against accidental start by another person.**
- **Clean the internal parts of the fan and any manipulation in these areas unless the fan is switched off and secured against accidental start by another person.**



**Before starting work, the operator is obliged to check the equipment for signs of damage or other properties that could lead to a threat to health or property. If such a defect is detected, the operator must not start the machine or otherwise continue working on it (report to the responsible employee).**

**Before starting operation for the first time, check the following points:**

- The electrical connection has been made correctly and completely.
- The protective conductor has been connected – the motor protection has been installed.
- The safety and security devices are in place.
- Remnants of installation material and foreign objects and materials have been removed from the fan housing area.

**When starting up for the first time, check the following points:**

- The connection data corresponds to the specifications on the nameplate: Maximum voltage +6%, -10%, according to IEC 38. The rated current must not be exceeded by more than 5% at the rated voltage.
- Check that the motor protection is functional.
- The direction of rotation must correspond to the arrow indicating the direction of rotation (3 phases).
- Check that the motor runs smoothly (no unusual noises).



**After the forced shutdown of the fan, wait 5 minutes. Only after this time has elapsed can the fan be restarted. In the event that the protection is turned off again in a short time, the electrical installation must be entrusted to a qualified person.**

## 6.2 CORRECT USE / IMPROPER USE

### 6.2.1 Type of extracted material

**SUITABLE FOR EXTRACTING:**

- Wood dust
- Small chips
- Sawdust
- Dry chips and dust without moisture

**UNSUITABLE FOR EXTRACTING:**

- Wet materials, liquids
- Working in an environment where there is a risk of explosion
- Flammable or explosive vapors
- Potentially explosive metal powder
- Metal powder

- Powder that may be explosive by its nature or reaction.
- Material that can cause sparks and incandescent material

**WORKING ENVIRONMENT:**

- Material originating from processing operations in the wood industry.

### 6.3 IN THE CASE OF FIRE



***Before proceeding, ensure that the procedure is carried out safely and using the correct means according to the company's emergency and evacuation plan.***



***urning produces gases that can be hazardous to health if inhaled. The gases continue to be produced even after the flames have been extinguished.***



***The workplace must be equipped with an appropriate fire extinguisher, see chapter 5 Smoking, welding or using open flames.***

- 1) Stop the machine, disconnect the power
- 2) Contact the fire department.
- 3) If conditions are safe, use a portable fire extinguisher and try to smother the fire.

FIRE EXTINGUISHER – see chapter “3.9 Fire safety”.

# 7. MAINTENANCE

## 7.1 MAINTENANCE RECOMMENDATIONS



**Carefully read the instructions in this manual before performing any maintenance.**



**Perform maintenance activities using the personal protective equipment described in the manual.**



**Do not perform any maintenance while the machine is in operation or connected to a power source.**

**Before any maintenance or repair work:**

- **Switch off the machine.**
- **Disconnect the power source.**



**Always wear suitable footwear to prevent electrostatic discharge before performing any maintenance intervention.**



**To avoid the risk of fire or explosion, never smoke or use open flames inside or near the fan during maintenance or cleaning.**



**To avoid the risk of fire or explosion, never use mobile phones or other similar devices inside or near the fan during maintenance or cleaning.**

The entire device must be kept clean to prevent dirt from causing malfunctions in the moving parts. The cleanliness must be checked and cleaned after each work shift or, if necessary, during the shift.

**Before performing maintenance, service or repairs, ensure the following:**

- The power supply must be switched off (by pulling the plug from the power socket).
- The fan impeller is completely stopped.
- Follow all safety regulations.
- The fan must be cleaned as needed, at least once per shift, to prevent dust from settling on the fan housing and motor.
- In the event of increased fan vibrations (due to the ingress of a larger piece of waste), the impeller must be replaced to prevent damage to the bearings and bushings in the motor shield (balancing or replacement is carried out by a service organization).

If a defect in the fan, excessive vibrations or damage to the impeller is detected, it must be immediately taken out of service and professional repairs must be arranged. The fan is serviced by the manufacturer.

## 7.2 PROHIBITED ACTIVITIES WITH THE FAN

***It is forbidden to operate the fan with any defect in the structure or mechanism of the machine and without the safety features of the machine.***

***It is forbidden to work with the fan under the influence of alcohol, drugs or medication that may reduce the ability to react and pay attention.***



***It is forbidden to start the fan if unauthorized persons are present at a dangerous distance or in a dangerous area near the fan or connected machine.***

***It is forbidden to remove waste from dangerous places while the fan is running.***

***It is forbidden to touch the moving parts of the fan with your body, or with objects and tools.***

***It is prohibited and must never be disabled or removed or disabled the functions of safety devices.***



***It is prohibited to carry out maintenance, cleaning and repairs while the fan is running and if the fan is not secured against accidental or automatic start.***

***It is prohibited to operate the fan in violation of the requirements for ensuring work safety - see safety instructions.***

## 7.3 TABLE OF SCHEDULED MAINTENANCE INTERVALS



***It is recommended to keep a maintenance register to preserve the history of the interventions carried out.***

Routine maintenance operations should be performed at the interval shown in the table below.

Operation / Check interval	Very often	Often		Occasionally	
	24 hrs	250 hrs	500 hrs	1 000 hrs	1 500 hrs
Check whether the extraction efficiency is sufficient.	X				
Check the condition of the power cables.				X	
Check the extraction device for vibrations or excessive noise.		X			

## 7.4 CLEANING AND DISPOSAL



**Perform maintenance activities using the personal protective equipment described in the manual.**



**Improper cleaning can cause contamination to escape into the environment and/or workplace.**



**Do not disperse polluting material into the environment.**

## 8. PARTS REPLACEMENT INFORMATIONS

If you need to order spare parts or any accessories, please proceed as follows:

1. Look for the machine type and machine serial number - both can be found on the serial plate.
2. If possible, find the sales invoice number.
3. Contact the sales representative from whom you purchased the machine or directly ADAMIK Company at the following contacts:  
Email: [info@adamikcompany.com](mailto:info@adamikcompany.com)  
Phone: +420 774 883 858

### 8.1 RECOMMENDATIONS FOR REPLACEMENT OF SPARE PARTS



**Read section "7 Maintenance" before any replacement.**



**Machine replacement or repair operations are reserved for qualified, trained and authorized personnel employed by the manufacturer or an authorized dealer.**



**Turn off the machine and disconnect all electrical sources.**



**To avoid the risk of fire or explosion, never smoke or use open flames inside or near the fan during maintenance or cleaning.**



**To avoid the risk of fire or explosion, never use mobile phones or other similar devices inside or near the fan during maintenance or cleaning.**

## 8.2 LIST OF REPLACEABLE PARTS

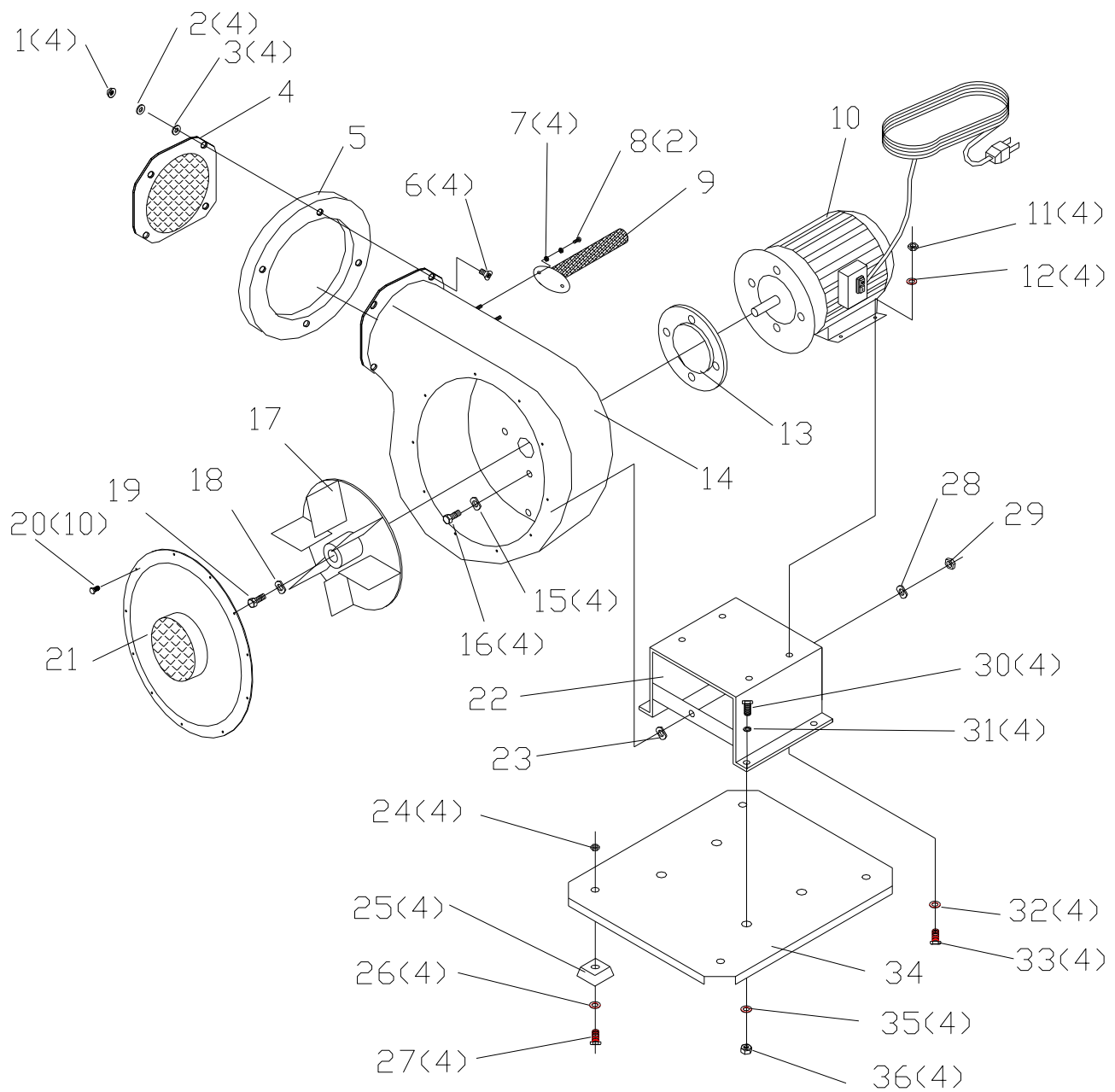

Number	Item	Pcs.
1	Cap nut 1/4"	4
2	Lock washer 1/4"	4
3	Flat washer (od 16 mm) 1/4"	4
4	Octagonal flange	1
5	Outlet gasket	1
6	Flat head screw 1/4" x 1"	4
7	Lock washer 5/16"	4
8	Cap nut 5/16"	2
9	Handle	1
10	Motor	1
11	Nut 5/16"	4
12	Flat washer (od 18 mm) 5/16"	4
13	Motor gasket	1
14	Blower housing	1
15	Hex HD screw 5/16" x 3/4"	4
16	Flat washer (od 23 mm) 5/16"	4
17	Impeller d=268 mm	1
18	Special flat washer	1
19	Special screw	1
20	Pan HD screw M4.2 x 12 mm	10
21	Inlet disc	1
22	Motor base	1
23	Flat washer (od 23 mm) 5/16"	1
24	Nut 1/4"	4
25	Rubber foot	4
26	Flat washer(od 16 mm) 1/4"	4
27	Hex HD screw 1/4" x 3/4"	4
28	Flat washer (od 23 mm) 5/16"	1
29	Hex nut 5/16"	1
30	Hex HD screw 5/16" x 5/8"	4
31	Lock washer 5/16"	4
32	Flat washer (od 23 mm) 5/16"	4
33	Hex HD screw 5/16" x 1"	4
34	Base	1
35	Flat washer (od 23 mm) 5/16"	4
36	Hex nut 5/16"	4



## 8.3 DECOMMISSIONING

The machine does not present any particular problems for decommissioning. Care must be taken to prevent unauthorized persons from starting the machine.

Comply with the laws in force in the country of use for any legal and tax aspects (any reports, complaints, etc.).



**When finally decommissioning the machine (at the end of its service life), keep in mind the interest and aspect of environmental protection and recycling options: drain the contents of the liquids into specially designated containers – namely liquids such as engine oil, transmission oil, cooling and cleaning fluids, and send them to specialized facilities. Dispose of toxic waste (e.g. batteries) according to regulations. Separate plastic materials and offer them for recycling. Separate metal parts by type for scrapping.**

Component	Material	Treatment	Note
Unit construction, impeller	Steel	 RECYCLABLE STEEL	
Electrical controls and components	OEEZ		Information on the correct disposal of these items can be found in the currently valid regulations of the country where the machine is installed.



### STEEL.

Fully recyclable..



### OEEZ.

Information on the correct disposal of these items can be found in the current applicable regulations.

## 9. WARRANTY

The warranty period is 12 months from the date of sale.

The warranty does not apply to defects resulting from improper handling or use for purposes other than those specified in the operating instructions.

### 9.1 LIABILITY FOR DEFECTS

By law, the manufacturer is liable under the contracts for consideration (purchase, work, etc.) for the fact that the goods or performance at the time of delivery are free of defects. Liability applies to all parts (except point 9.3) as well as to labor, transport and travel costs. Any consequential damages are excluded.

**Consumer buyer - legal liability for defects for a period of 2 years** from the date of issue of the sales document.

**Buyer entrepreneur - pays liability for defects for 6 months** from the date of issue of the sales document. In single shift operation.

Additional arrangements always require written form, oral promises are not valid.

### 9.2 VOLUNTARY ADDITIONAL WARRANTY

Compared to the statutory liability for defects, a voluntary additional guarantee is a voluntary undertaking that the goods or performance beyond the statutory liability for defects will remain free of defects for a certain period of time. The guarantee requires a written form. Oral agreements are excluded. The warranty only applies to mechanical parts (with the exception of point 9.3), it does not apply to labor, transport and travel costs. Any consequential damages are excluded.

The seller provides a **warranty for a period of 12 months or a maximum of 1600 operating hours for parts of mechanical components** (except point 9.3).

The seller provides a **warranty for 6 months for spare parts** (except point 9.3).

In the case of used goods, only the statutory provisions on liability for defects apply, which is 1 year for the consumer buyer and 3 months for the entrepreneur buyer.

### 9.3 EXCLUSIONS FROM LIABILITY FOR DEFECTS AND FROM WARRANTY

- If the defect did not occur at the time of delivery.
- In case of damage to the goods during transport (these damages must be resolved with the shipping company upon receipt, all shipments are sent insured).
- Defects caused by improper use or overloading (classification of hobby use, craftsman, professional, industrial).
- Defects caused by unprofessional installation, unprofessional commissioning, unprofessional handling, operation or storage or neglect of care of the goods.
- If the prescribed operating or installation conditions are not observed (main board of the machine, electrical distribution, compressed air distribution, exhaust distribution).
- If a defect has occurred due to improper handling or external forces (eg. scratches, dents, twists, etc.).

- No liability is accepted for all consequential damages (such as unforeseeable damages).
- No liability is accepted for wear related to the appearance and as a result of everyday use (eg. paint damage, scratches, etc.).
- Does not accept responsibility for any defects caused by pollution.
- No liability is accepted for defects caused by non-compliance with the instructions in the operating instructions or maintenance instructions or arising from use that is in conflict with the operating instructions or normal use.
- No liability is accepted for consumable parts (eg. bearings, belts, gears, segments, threaded rods, threaded nuts, teeth, gears, chip breakers...) as well as plastic parts (eg. handles, levers, stickers, plugs, covers, squeegees, roller carriers, rubberized rolls...).
- No liability is accepted for defects caused by modifications, repairs, sharpening and manipulations not performed by the authorized personnel of the manufacturer or certified dealer or the authorized service of the manufacturer or certified dealer.
- No liability is accepted for defects resulting from corrosion, fire or water damage.
- No liability is accepted for defects resulting from external influences, such as 2-phase operation, faulty electrical protection, undervoltage, overvoltage (visibly burned components or printed circuits) except for normal deviations, lightning strikes.
- Liability according to the valid regulations of the given country for motors, electric switches/ switches, electric control boards, etc.
- Violation of the protective seal, information label or serial number, unless damage occurs during normal use. Seals and serial numbers are an integral part of the goods and do not limit the buyer's right to use and manipulate the goods to the full extent of what the goods are intended for.
- Electrical use of goods in conditions that do not correspond to their temperature, dust, humidity, chemical and mechanical influences of the environment, which is directly determined by the seller or manufacturer.
- Damage caused by excessive loading or use contrary to the conditions stated in the documentation or general principles.
- Performing an unqualified intervention or changing parameters.
- Goods that have been adjusted by the customer (painting, bending, etc.), if the defect was a result of this adjustment.
- Damage from natural elements or force majeure.
- The use of incorrect or non-genuine consumables, or any damage resulting therefrom, unless such use is normal and has not been ruled out in the operating instructions.

## 10. TERMS OF SERVICE

in the event of any malfunction during the warranty or post-warranty period, contact the manufacturer or a certified dealer or service center.



## CE DECLARATION OF CONFORMITY CE PROHLÁŠENÍ O SHODĚ

**The manufacturer / Výrobce:** ADAMIK Company, s.r.o.  
**Registered office / Sídlo společnosti:** Mitrovická 804, 739 21 Paskov, Czech Republic

**whose responsibility for the relevant technical document is / jehož odpovědnost za příslušný technický dokument nese:**

**Name / Jméno** Ing. Petr Adamík

**declares under his own responsibility that the machine / na svou vlastní zodpovědnost prohlašuje, že strojní zařízení:**

**Product / Výrobek:** Transport ventilator/ *Transportní ventilátor*  
**Type / Typ:** VAN 100 0,75 kW

**Serial number / Výrobní číslo:** .....  
**Year of production / Rok výroby:** .....

complies with the requirements given in the Machinery Directive **2006/42/CE** and Low Voltage Directive **2014/35/CE**, as amended by the subsequent directives issued by the EEC Council.

Provided that the product it is used and maintained in accordance with the generally accepted codes of good practice and the recommendations of the instructions manual, meets the essential safety and health requirements of the Machinery Directive.

For the most specific risks of this machine, safety and compliance with the essential requirements of the Directive has been based on elements of:

- **EN ISO 12100:2010** - Safety of machinery, General principles for design, Risk assessment and risk reduction
- **EN 60204-1:2006+A1:2009+AC:2010** - Safety of machinery - Electrical equipment of machines- Part 1: General requirements- Industrial electrical device.

The manufacturer undertakes to transmit all the papers, in response to a reasoned request of the competent national authorities, with relevant informations on this almost-machine and leaves intact his intellectual property rights. /

*splňuje požadavky Směrnice o strojních zařízeních **2006/42/ES** a Směrnice o zařízeních nízkého napětí **2014/35/ES**, ve znění následných směrnic vydaných Radou EHS.*

*Za předpokladu, že je výrobek používán a udržován v souladu s obecně uznávanými kodexy správné praxe a doporučeními návodu k obsluze, splňuje základní požadavky na bezpečnost a ochranu zdraví stanovené směrnicí o strojních zařízeních.*

*Pro nejspécifitější rizika tohoto stroje byla bezpečnost a shoda se základními požadavky směrnice založena na prvcích:*

- **EN ISO 12100:2010** - *Bezpečnost strojních zařízení, Obecné zásady pro konstrukci, Hodnocení rizik a snižování rizik*

- **EN 60204-1:2006+A1:2009+AC:2010** - Bezpečnost strojních zařízení - Elektrická zařízení strojů - Část 1:  
Obecné požadavky - Průmyslová elektrická zařízení.

Výrobce se zavazuje předat veškeré dokumenty na základě odůvodněné žádosti příslušných národních orgánů  
s příslušnými informacemi o tomto stroji a ponechává svá práva duševního vlastnictví nedotčena. /

**Place, date / Místo, dne:** Paskov, 2.4.2025

**Legal representative / Zákonný zástupce společnosti:**

Ing. Petr Adamík, CEO / Ing. Petr Adamík, jednatel společnosti

**ADAMIK Company, s.r.o.** ①  
CZ-190 00 PRAHA 2, Pařížkova 910/9  
IČ: 26845318 / OIČ: CZ26845318

# PRODUCT QUALITY AND COMPLETENESS CERTIFICATE

**Ventilator:**

VAN 100

.....

<b>Serial number:</b>	<b>Checked by:</b>	<b>Date:</b>
-----------------------	--------------------	--------------

<b>Date of sale:</b>	<b>Delivered by:</b>
----------------------	----------------------

**Service / repair protocol:**

<b>The date of acceptance for repair:</b>	<b>Description:</b>	<b>Repaired by:</b>

v.2025.04

---

ADAMIK Company, s.r.o.  
Mitrovická 804, 739 21 Paskov  
Czech Republic

VAT ID: CZ26845318  
Tel.: +420 774 883 858  
e-mail: info@adamikcompany.com

[www.adamikcompany.com](http://www.adamikcompany.com)